

# OsseoSpeed™ TX Profile

Clinical procedures & Product catalog





# Adapting with nature

OsseoSpeed™ TX Profile – anatomically designed implants for sloped ridges

Imagine being able to achieve 360° bone preservation around the implant, even in cases with sloped ridges. Now you can.

With OsseoSpeed™ TX Profile – a uniquely shaped, patented implant, specifically designed for sloped ridge situations – you no longer have to choose between buccal and lingual marginal bone preservation and esthetics, you can have it all – 360° around the implant.

# Contents

<b>Introduction</b> .....	4
<b>Implant overview</b> .....	5
Intended use .....	5
OsseoSpeed™ TX Profile assortment .....	5
<b>Clinical considerations</b> .....	6
Pre-operative procedures .....	6
Implant positioning .....	6
<b>Surgical overview</b> .....	7
OsseoSpeed™ TX Profile – surgical handling .....	7
OsseoSpeed™ TX Profile – dimensions .....	7
Step-by-step procedures .....	8
<b>Restorative overview</b> .....	12
Step-by-step procedures .....	12
Cement-retained restorations .....	14
Screw-retained restorations .....	14
<b>Torque guide</b> .....	15
<b>Product catalog</b> .....	16
<b>Index</b> .....	22

This manual is designed for dental professionals who have experience with dental implant treatment and as a complement to the surgical and restorative manuals for the Astra Tech Implant System™. It highlights and emphasizes the special considerations needed when planning and performing treatment with OsseoSpeed™ TX Profile implants.

## Introduction

The applications of osseointegration and dental implant therapy have developed over the last 30 years. Today we can provide predictable and reliable treatment results when replacing missing teeth with dental implants. Research and development have improved implant design and surface properties and effective and secure treatment protocols have been established. For over twenty-five years, we at Astra Tech, have been committed to developing implant features that work in harmony with nature. Long-term documentation on the Astra Tech Implant System™ proves our success, not only in implant survival, but also in predictable peri-implant marginal bone stability.

However, how well the implant adapts to the profile of the alveolar ridge, is an area that has been overlooked. With today's implant design, an optimal bone/implant relation is only possible when the peri-implant bone is at the same level around the implant neck.

### Compromised implant placement with a sloped alveolar ridge

An implant placed in level with the buccal bone margin leaves the lingual/palatal and proximal bone coronal to the implant without biomechanical support. We can foresee remodeling and loss of bone and soft tissue height, resulting in less than optimal esthetic results.

An implant placed in level with the palatal/lingual bone margin leaves the implant protruding out of the bone on the buccal side. This can result in discoloration of the buccal soft tissue margin or, in a worst-case scenario, a soft tissue dehiscence, causing compromised esthetics.

Neither of these alternatives are optimal.

### OsseoSpeed™ TX Profile

The optimal solution in a sloped ridge situation is to have a sloped implant that is designed to be in harmony with the ridge profile, preserves the marginal bone and supports the soft tissue all around the implant.

The Astra Tech Implant System™, with the Astra Tech BioManagement Complex™, is documented to provide marginal bone level maintenance. The OsseoSpeed TX Profile is a result of a small modification to the OsseoSpeed TX implant design that makes a big difference for providing long-term esthetic results in sloped ridge situations.





# Implant overview

OsseoSpeed™ TX Profile implants are based on the documented key features and benefits of the Astra Tech BioManagement Complex™; OsseoSpeed™, MicroThread™, Conical Seal Design™ and Connective Contour™.

## Intended use

The intended use for OsseoSpeed™ TX Profile is the same as for OsseoSpeed™ TX. In addition, the OsseoSpeed™ TX Profile is specially designed to be used in situations with a sloped ridge profile in:

- healed alveolar ridges
- extraction sockets (immediate installation)

<b>OsseoSpeed™ TX Profile</b>	<p><b>4.5</b></p>  <p>4.5 mm 1.9 mm</p>	<p><b>5.0</b></p>  <p>5.0 mm 2.4 mm</p>	<p><b>5.0 S</b></p>  <p>5.0 mm 3.2 mm</p>
<b>Indications</b>	In all positions in the jaws. Single tooth to full arch.	In all positions in the jaws. Single tooth to full arch.	In all positions in the jaws. Especially indicated for wide ridges and large edentulous spaces. Single tooth to full arch.

## OsseoSpeed™ TX Profile assortment

Components specifically designed for use with OsseoSpeed™ TX Profile implants are presented in this manual/product catalog. Do not interchange components designed for the OsseoSpeed™ TX Profile and OsseoSpeed™ TX, with the exception of the Healing Abutment and Healing Abutment Uni assortments for OsseoSpeed™ TX 4.5/5.0, which are verified products also for the OsseoSpeed™ TX Profile.

OsseoSpeed™ TX Profile products and packaging are not color-coded and therefore, labels are white.

This manual only addresses the additional information needed to work with the OsseoSpeed™ TX Profile and optimize the final outcome when using this implant.

For all other instructions and/or a full description of the Astra Tech Implant System™ – implant placement, restorative procedures and all instruments and components needed – please refer to the Surgical procedure manual, Cement-retained restorations manual and the Product catalog.

If you are not familiar with Atlantis™ patient-specific abutments, please contact your laboratory and/or your Astra Tech representative. For more information visit [www.atlantisabutment.com](http://www.atlantisabutment.com).



## Clinical consideration

To take full advantage of all the benefits of the OsseoSpeed™ TX Profile, please note the important steps in the treatment process, including pre-operative procedures and implant positioning.

### Pre-operative procedures

Transparent Radiographic Implant Guides for OsseoSpeed™ TX Profile that present the implants in different magnifications, are available for preoperative planning. A sagittal tomographic radiograph showing an appropriate view of the ridge profile could be useful for planning the optimal implant position and direction. Computer guided implant treatment software, such as Facilitate™, can also be helpful in ensuring accurate planning for optimal implant position.

### Implant positioning

Only one position of the implant slope is optimal i.e. correct vertical and rotational position in relation to the buccal bone. Therefore, careful drilling and implant placement procedures, particularly for the OsseoSpeed™ TX Profile 4.5 and 5.0 (conical) implants are required. Over-torquing may jeopardize marginal bone integrity due to unfavorable stress generation. Place the implant in line with the buccal bone level to provide support of the marginal bone around the implant. It is important to note that a full 360° turn is equal to a 0.6 mm change in vertical position.



## Surgical overview

### OsseoSpeed™ TX Profile – surgical handling

The same handling procedure as for the OsseoSpeed™ TX implants applies. However, steps such as preparation and measuring of the osteotomy and the implant placement require more specific protocols.

From a mechanical strength point of view, it is recommended to always place as wide an implant as possible. This is particularly important in the posterior regions of the jaws where loading forces are high and considerable bending moments could be generated.



### Implant slope variance

As a result of the sloped neck design, the height of the lingual/palatal side as compared to the buccal side of the implant has a variance of 1.5–1.7 mm depending on the implant diameter, as illustrated below:

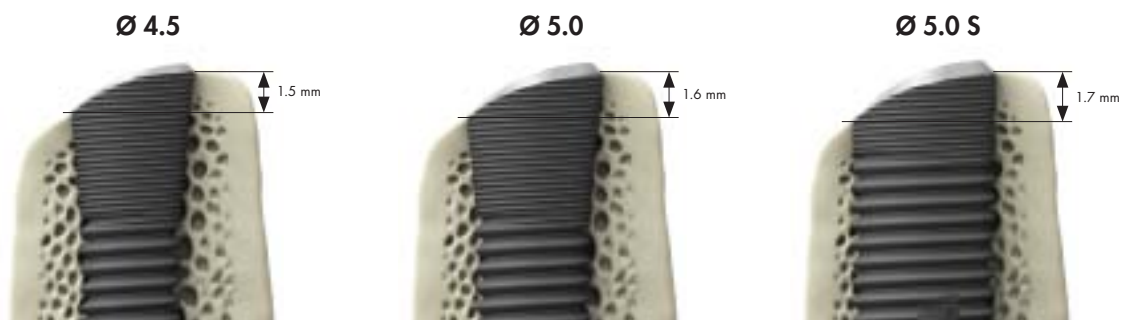

### Drill depth requirements

In relation to the buccal wall of the prepared site, the required drill depth should be **no more than 1.5 mm shorter** than the implant length (i.e.: for a 13 mm implant, a drill depth minimum of 11.5 mm on the buccal wall is necessary.)

**Note:** A full 360° turn of the implant is equal to a 0.6 mm change in vertical position.

## Step-by-step drilling procedure for OsseoSpeed™ TX Profile 5.0, 13 mm – standard drilling protocol\*



- The starting point should be approximately 3 mm buccally to the most coronal point of the ridge.

\*For soft and dense bone drilling protocols, see Surgical procedures manual.

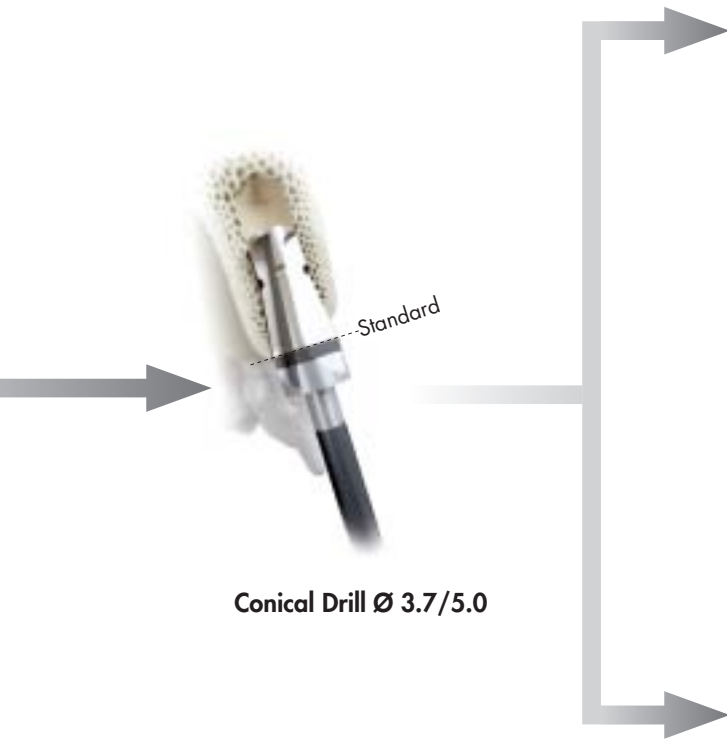

**Conical Drill Ø 3.7/5.0**

- For standard drilling protocol, drill to the beginning of the depth indication line.



**Implant Depth Gauge palatal**

- Place the Depth Gauge against the palatal and the buccal walls of the osteotomy to verify the drilling depth.



**Implant Depth Gauge buccal**

- Make sure there is enough depth provided for the entire implant. For the 5.0,13 mm implant, the buccal depth should be at least 11.5 mm.
- If the depth is less than 11.5 mm, additional drilling with a twist drill is required, and may be followed by the conical drill depending on the clinical situation.
- If the depth for the 5.0,13 mm implant, is more than 11.5 mm, make sure to stop the implant installation at or slightly apical to the buccal margin.

## Step-by-step implant placement procedure for OsseoSpeed™ TX Profile Ø 5.0 mm, 13 mm



### Pick-up

- Attach the Implant Driver Profile to the Contra Angle.
- Align the buccal side of the implant (most apical point of the slope) with the marking on the Implant Driver Profile. Make sure that the driver is properly seated.
- Pick up the implant from the inner container.

### Installation

- Install the implant with a contra angle at low speed (25 rpm) under profuse irrigation.
- Set the maximum torque to 35 Ncm. Let the implant work its way into the osteotomy and avoid applying unnecessary pressure.
- Keep in mind the position of the buccal side of the implant before removing the driver.

### Positioning

- The Ratchet Wrench, in combination with the Driver Handle, may be used for the final manual seating of the implant.
- Position the marking on the driver buccally to facilitate optimal placement of the implant.
- The driver must be properly seated to be used for measuring purposes.
- It is important to realize that a full 360° turn is equal to a 0.6 mm change in vertical position.
- Release the Implant Driver Profile by lifting it gently from the implant.



### Optional

- The Implant Transfer Profile and the Implant Pick-up Profile are designed to seat the implant in one position only so they can be used to confirm the most apical point of the slope.

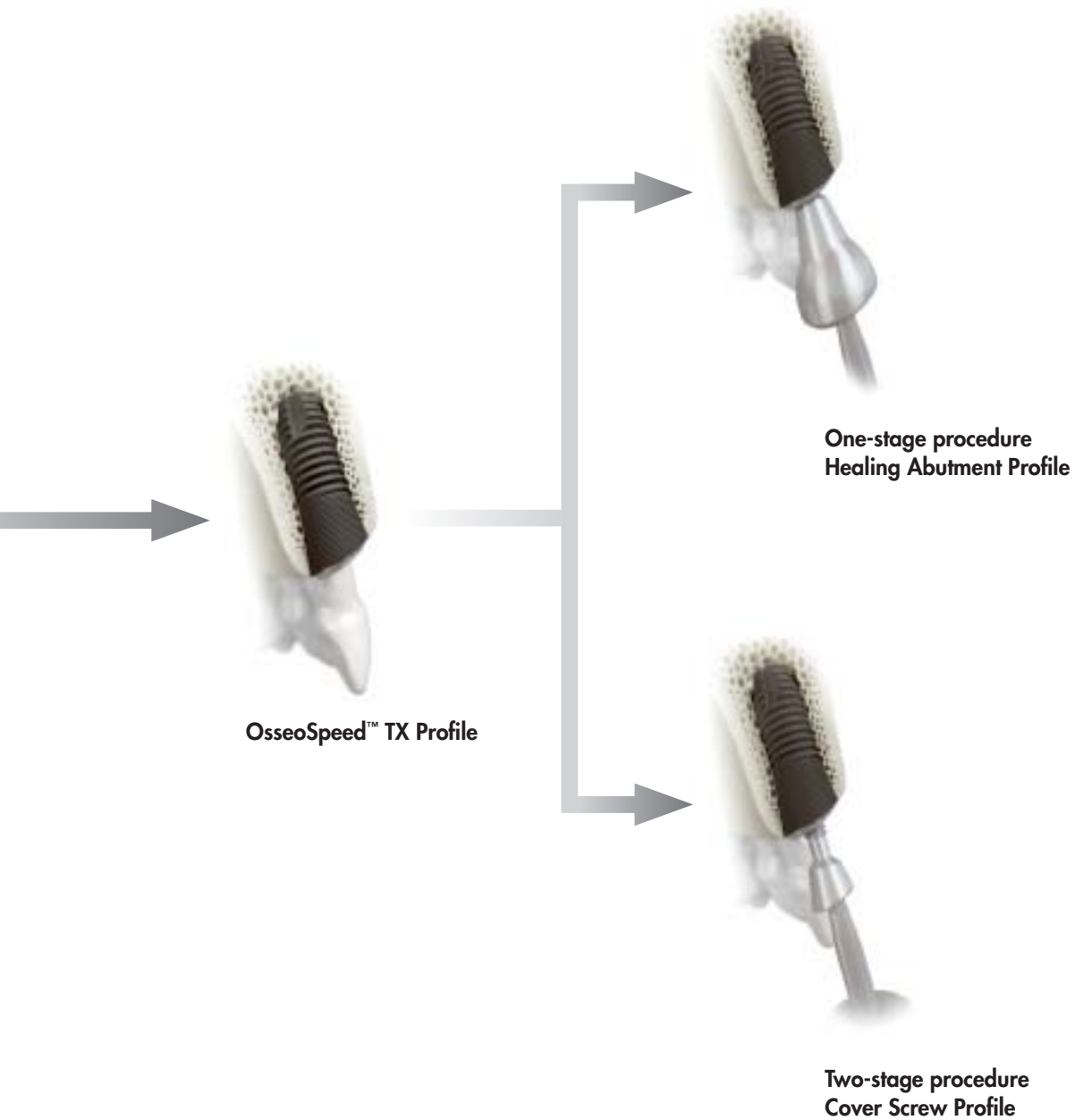

- Healing Abutment Profile and Cover Screw Profile have timed threading to ensure correct alignment with the implant slope.
- Use light finger force (5–10 Ncm) to seat the healing abutment or cover screw with a Hex Screwdriver.
- When placing the healing abutment or cover screw, be sure not to use a torque that might create further rotation of the implant.

## Step-by-step implant-level impression procedure for OsseoSpeed™ TX Profile

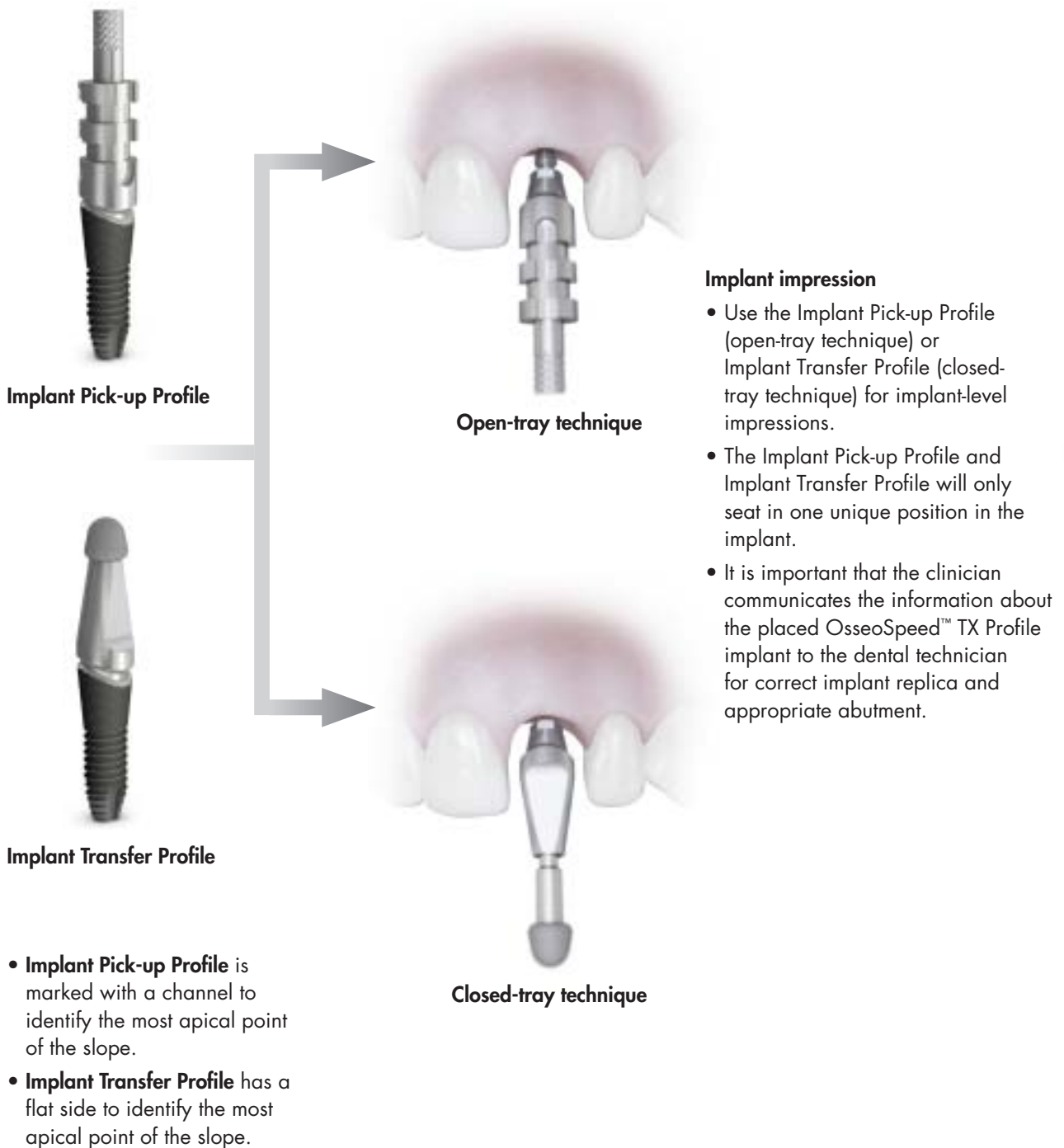

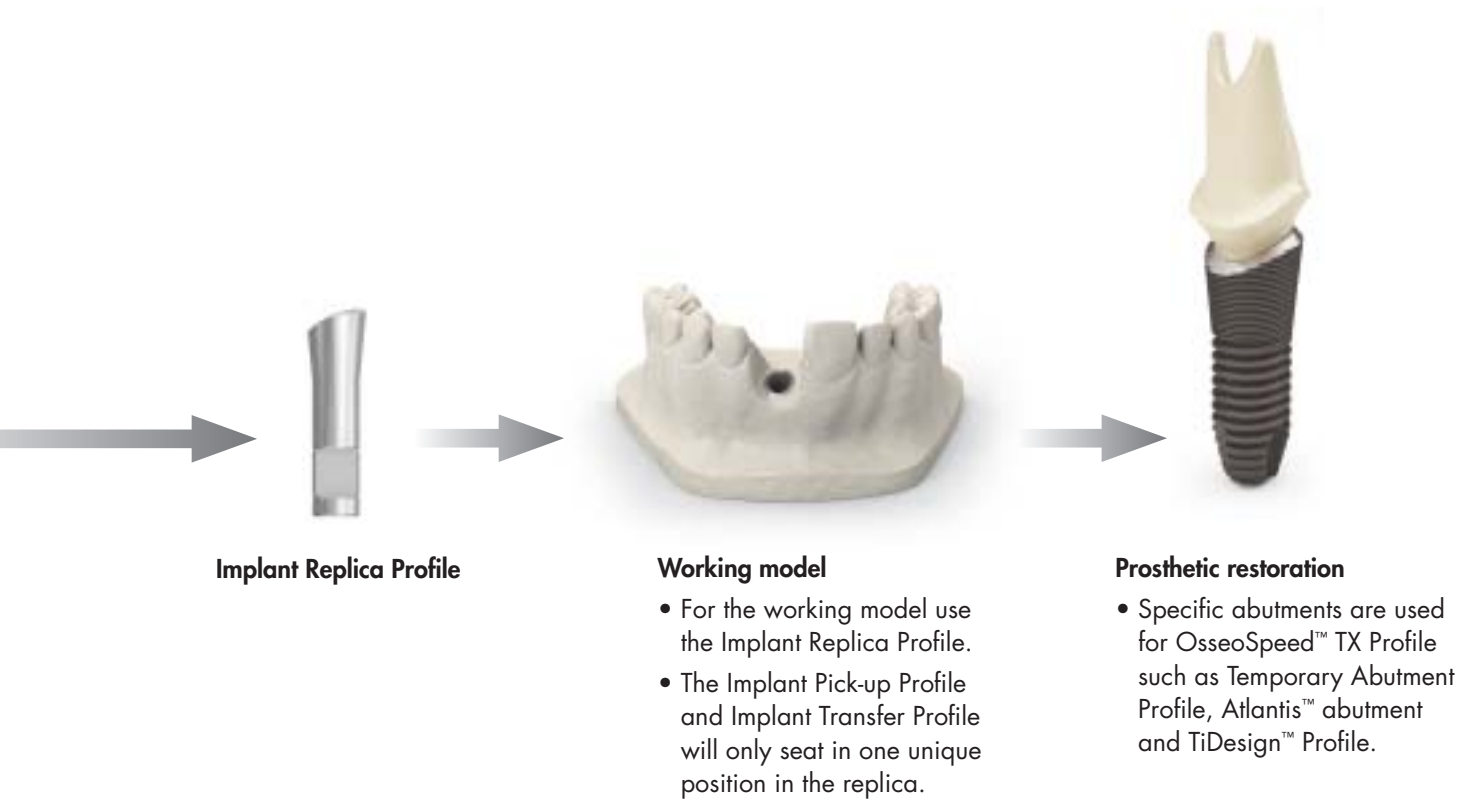







## Cement-retained restorations

The same handling procedures apply as for the OsseoSpeed™ TX implants. The following cement-retained restorative options are available for OsseoSpeed™ TX Profile.

Abutments designed for implant-level impression	Indications and intended use	Features and benefits
<p><b>Atlantis™ abutment</b> – titanium  <b>Atlantis™ abutment</b> – GoldHue™  <b>Atlantis™ abutment</b> – zirconia*, four shades</p> 	<ul style="list-style-type: none"> <li>• Single, partial and fully edentulous situations</li> <li>• All positions in the mouth</li> </ul> <p><b>Note:</b> Use of zirconia abutments should be carefully evaluated when placed in situations with unfavorable loading conditions.</p>	<ul style="list-style-type: none"> <li>• Patient-specific abutment designed from the final tooth shape</li> </ul>
<p><b>TiDesign™ Profile</b>                      Titanium</p> 	<ul style="list-style-type: none"> <li>• Single, partial and fully edentulous situations</li> <li>• All positions in the mouth</li> </ul>	<ul style="list-style-type: none"> <li>• Pre-designed and for easy adjustment</li> <li>• Straight and angled versions available</li> </ul>
Abutment for Temporization	Indications and intended use	Features and benefits
<p><b>Temporary Abutment Profile</b>                      Titanium</p> 	<ul style="list-style-type: none"> <li>• Single, partial and fully edentulous situations</li> <li>• All positions in the mouth</li> <li>• Cement- and screw-retained temporary restorations</li> </ul>	<ul style="list-style-type: none"> <li>• Ideal for long-term temporization</li> </ul>

\* For the available options, please refer to the most current Atlantis™ Implant compatibility chart.

## Screw-retained restorations

Abutments designed for implant-level impression	Indications and intended use	Features and benefits
<p><b>Atlantis™ crown abutment, zirconia</b></p> 	<ul style="list-style-type: none"> <li>• Single-tooth situations</li> <li>• All positions in the mouth</li> </ul> <p><b>Note:</b> Use of zirconia abutments should be carefully evaluated when placed in situations with unfavourable loading conditions.</p>	<ul style="list-style-type: none"> <li>• Patient-specific abutment designed from the final tooth shape</li> <li>• Porcelain is applied directly to the abutment</li> <li>• Allows for easy retrieval</li> </ul>

### Laboratory Abutment Screw







To ensure that an uncompromised screw is used in the clinical situation, use the Laboratory Abutment Screw for laboratory procedures.

### Implant impression

Use the Implant Pick-up Profile (open-tray technique) or Implant Transfer Profile (closed-tray technique) for implant-level impressions. For the working model use the Implant Replica Profile.



## Recommended tightening torque

Type of product		Torque – Ncm
Cover Screw Profile		Manual*
Healing Abutment Profile		Manual*
Temporary Abutment Profile		15
Atlantis™ abutment		25
Atlantis™ crown abutment		25
TiDesign™ Profile		25

\*Only light finger force (5–10 Ncm) using a manual screwdriver.

# Product catalog

## OsseoSpeed™ TX Profile

Components specifically designed for use with OsseoSpeed™ TX Profile implants are presented in this manual/product catalog. Do not interchange components designed for the OsseoSpeed™ TX Profile and OsseoSpeed™ TX, with the exception of the Healing Abutment and Healing Abutment Uni assortments for OsseoSpeed™ TX 4.5/5.0, which are verified products also for the OsseoSpeed™ TX Profile. Products and packaging for OsseoSpeed TX Profile are not color-coded and therefore, labels are white.

If you need drills and other instruments, please refer to the Product catalog for Astra Tech Implant System™. If you are not familiar with Atlantis™ patient-specific abutments, please contact your laboratory and/or your Astra Tech representative. For more information visit [www.atlantisabutment.com](http://www.atlantisabutment.com).



# Product overview OsseoSpeed™ TX Profile

## Implants

### OsseoSpeed™ TX Profile 4.5



9 mm 25029  
11 mm 25030  
13 mm 25031  
15 mm 25032  
17 mm 25033

### OsseoSpeed™ TX Profile 5.0



9 mm 25034  
11 mm 25035  
13 mm 25036  
15 mm 25037  
17 mm 25038

### OsseoSpeed™ TX Profile 5.0 S



9 mm 25039  
11 mm 25040  
13 mm 25041  
15 mm 25042  
17 mm 25043

## Cover screws

### Cover Screw Profile



0 mm 25044

## Healing abutments

### Healing Abutment Profile



Ø 6.0 2 mm 25045  
Ø 6.0 4 mm 25046

## Cement-retained

### Temporary abutments

#### Temporary Abutment Profile



Ø 5.3 1.5 mm 25052

### Abutments

#### TiDesign™ Profile



Ø 5.5 1.8 mm 25053  
Ø 5.5 3.0 mm 25054  
Ø 6.5 1.8 mm 25055  
Ø 6.5 3.0 mm 25056  
Ø 6.2 15° 2.7 mm 25057

#### Atlantis™ abutments\*



Patient-specific abutments

## Implant impressions

### Implant Pick-up Profile

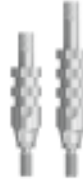

Short 25048  
Long 25049

### Implant Transfer Profile



Short 25050  
Long 25051

## Guide pins

### Implant Guide Pin 4.5/5.0



Short 24966  
Long 24967

## Replicas

### Implant Replica Profile



25047

## Lab abutment screws

### Lab Abutment Screw Design 4.5/5.0



24858

\*For the available options, please refer to the most current Atlantis™ Implant compatibility chart.

## Screw-retained

### Abutments

Atlantis™ crown abutment



**Note:** Healing Abutment and Healing Abutment Uni assortments for OsseoSpeed™ TX 4.5/5.0 can be used with OsseoSpeed™ TX Profile implants.

SURGICAL COMPONENTS

OsseoSpeed™ TX Profile

**OsseoSpeed™ TX Profile 4.5**

Titanium, Sterile

OsseoSpeed™, with a TiO<sub>2</sub>-blasted fluoride-modified surface.

MicroThread™ neck.

Conical Seal Design™ connection.

Internal hexagon.

Ø 4.5/3.5 mm

Internal thread M2

					
Length mm	9	11	13	15	17
REF	25029	25030	25031	25032	25033

**OsseoSpeed™ TX Profile 5.0**

Titanium, Sterile

OsseoSpeed™, with a TiO<sub>2</sub>-blasted fluoride-modified surface.

MicroThread™ neck.

Conical Seal Design™ connection.

Internal hexagon.

Ø 5.0/4.0 mm

Internal thread M2

					
Length mm	9	11	13	15	17
REF	25034	25035	25036	25037	25038

**OsseoSpeed™ TX Profile 5.0 S**

Titanium, Sterile

OsseoSpeed™, with a TiO<sub>2</sub>-blasted fluoride-modified surface.

MicroThread™ neck.

Conical Seal Design™ connection.

Internal hexagon.

Ø 5.0 mm

Internal thread M2

					
Length mm	9	11	13	15	17
REF	25039	25040	25041	25042	25043

**Radiographic Implant Guides Profile**

REF 25062



**Implant Driver Profile**

Used to engage and place implants.

Short drivers are ideal for the posterior region.

Short, 24 mm  
REF 25059

Long, 32 mm  
REF 25058



## Cover Screw Profile

Titanium, Sterile

Used to cover the implant connection during healing.



Ø mm	3.8
Height mm	0
REF	25044

### MEASUREMENTS

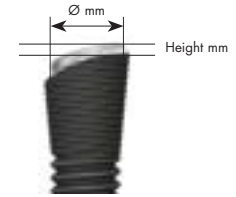

### SHORT FACTS

The Cover Screw Profile has timed threading to ensure correct alignment with the implant slope. Recommended torque – Manual. Only light finger force (5–10 Ncm) using a manual screwdriver.

## Healing Abutment Profile

Titanium, Sterile

**Note:** Healing Abutment and Healing Abutment Uni assortments for OsseoSpeed™ TX 4.5/5.0 can be used with OsseoSpeed™ TX Profile implants.



Ø mm	6.0	6.0
Height A mm	2	4
Height B mm	3.5	5.5
REF	25045	25046

### MEASUREMENTS

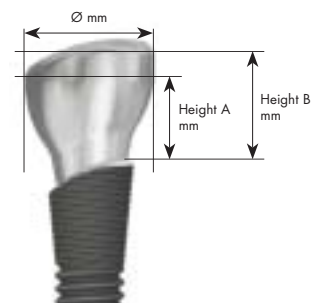

### SHORT FACTS

The Healing Abutment Profile has timed threading to ensure correct alignment with the implant slope. Recommended torque – Manual. Only light finger force (5–10 Ncm) using a manual screwdriver.



Marked with a "P" to identify Profile abutment. Marked with digits to identify diameter (Ø) and height.

## Temporary Abutment Profile

Titanium

Includes Abutment Screw Design 4.5/5.0 – M2, REF 24209 (Titanium)



Ø mm	5.3
Height bucc A mm	1.5
ling B mm	1.5
Vert. height mm	9
REF	25052

### MEASUREMENTS

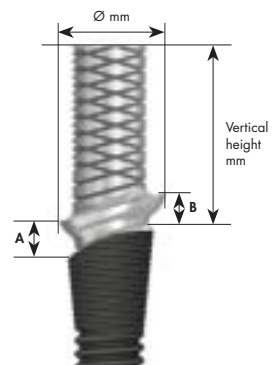

### SHORT FACTS

Recommended torque for temporization – 15 Ncm

OsseoSpeed™ TX Profile

### Implant Pick-up Profile

Titanium

Two piece component:  
sleeve and guide pin.

Length mm  
REF



	Short	Long
Length mm	22	27
REF	25048	25049



SHORT FACTS  
Marked with a channel  
to identify the most apical  
point of the slope.

### Implant Transfer Profile

Titanium

Internal thread.  
Two piece component:  
sleeve and pin.

Product  
Length mm  
REF



	Short	Long
Length mm	18	21
REF	25050	25051

SHORT FACTS  
The flat side identifies the most  
apical point of the slope.

### Implant Replica Profile

Titanium

Length mm  
REF



Length mm	15.5
REF	25047

### Implant Guide Pin 4.5/5.0

Titanium

Length mm  
REF



	Short	Long
Length mm	22	27
REF	24966	24967

### Lab Abutment Screw Design

Titanium

REF  
QTY



REF	24858
QTY	6 x M2

MEASUREMENTS

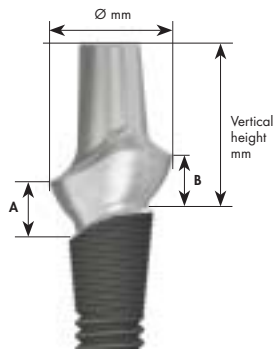

SHORT FACTS

Pre-designed for quick and easy adjustment.  
Recommended torque – 25 Ncm

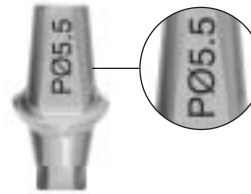

Marked with "P" to identify Profile abutment.  
Marked with digits to identify diameter (Ø).

**TiDesign™ Profile 4.5/5.0**

Titanium

Includes Abutment Screw Design  
4.5/5.0 – M2, REF 24209  
(Titanium)



Angulation					15°
Ø mm	5.5	5.5	6.5	6.5	6.2
Height bucc A mm	1.8	3	1.8	3	2.7
ling B mm	1.8	3	1.8	3	2.7
Vert. height mm	7	8	7	8	8.5
REF	25053	25054	25055	25056	25057

**Atlantis™ abutments**

If you are not familiar with Atlantis™ patient-specific abutments, please contact your laboratory and/or your Astra Tech representative. For more information visit [www.atlantisabutment.com](http://www.atlantisabutment.com).



### Order by reference number

REF		page
24209	Abutment Screw Design 4.5/5.0 – M2	21
24858	Lab Abutment Screw Design	20
24966	Implant Guide Pin 4.5/5.0 – Short	20
24967	Implant Guide Pin 4.5/5.0 – Long	20
25029	OsseoSpeed™ TX Profile 4.5 – 9 mm	18
25030	OsseoSpeed™ TX Profile 4.5 – 11 mm	18
25031	OsseoSpeed™ TX Profile 4.5 – 13 mm	18
25032	OsseoSpeed™ TX Profile 4.5 – 15 mm	18
25033	OsseoSpeed™ TX Profile 4.5 – 17 mm	18
25034	OsseoSpeed™ TX Profile 5.0 – 9 mm	18
25035	OsseoSpeed™ TX Profile 5.0 – 11 mm	18
25036	OsseoSpeed™ TX Profile 5.0 – 13 mm	18
25037	OsseoSpeed™ TX Profile 5.0 – 15 mm	18
25038	OsseoSpeed™ TX Profile 5.0 – 17 mm	18
25039	OsseoSpeed™ TX Profile 5.0 S – 9 mm	18
25040	OsseoSpeed™ TX Profile 5.0 S – 11 mm	18
25041	OsseoSpeed™ TX Profile 5.0 S – 13 mm	18
25042	OsseoSpeed™ TX Profile 5.0 S – 15 mm	18
25043	OsseoSpeed™ TX Profile 5.0 S – 17 mm	18
25044	Cover Screw Profile, Ø 3.8	19
25045	Healing Abutment Profile, Ø 6.0, 2 mm	19
25046	Healing Abutment Profile, Ø 6.0, 4 mm	19
25047	Implant Replica Profile	20
25048	Implant Pick-up Profile – Short	20
25049	Implant Pick-up Profile – Long	20
25050	Implant Transfer Profile – Long	20
25051	Implant Transfer Profile – Short	20
25052	Temporary Abutment Profile	19
25053	TiDesign™ Profile 4.5/5.0 – Ø 5.5, 1.8 mm	21
25054	TiDesign™ Profile 4.5/5.0 – Ø 5.5, 3.0 mm	21
25055	TiDesign™ Profile 4.5/5.0 – Ø 6.5, 1.8 mm	21
25056	TiDesign™ Profile 4.5/5.0 – Ø 6.5, 3.0 mm	21
25057	TiDesign™ Profile 4.5/5.0 – Ø 6.2, 2.7 mm, 15°	21
25058	Implant Driver Profile, 32 mm – Long	18
25059	Implant Driver Profile, 24 mm – Short	18
25062	Radiographic Implant Guides Profile	18

### Alphabetical order

REF		page
24209	Abutment Screw Design 4.5/5.0 – M2	21
25044	Cover Screw Profile, Ø 3.8	19
25045	Healing Abutment Profile, Ø 6.0, 2 mm	19
25046	Healing Abutment Profile, Ø 6.0, 4 mm	19
25058	Implant Driver Profile, 32 mm – Long	18
25059	Implant Driver Profile, 24 mm – Short	18
24966	Implant Guide Pin 4.5/5.0 – Short	20
24967	Implant Guide Pin 4.5/5.0 – Long	20
25048	Implant Pick-up Profile – Short	20
25049	Implant Pick-up Profile – Long	20
25047	Implant Replica Profile	20
25050	Implant Transfer Profile – Long	20
25051	Implant Transfer Profile – Short	20
24858	Lab Abutment Screw Design	20
25029	OsseoSpeed™ TX Profile 4.5 – 9 mm	18
25030	OsseoSpeed™ TX Profile 4.5 – 11 mm	18
25031	OsseoSpeed™ TX Profile 4.5 – 13 mm	18
25032	OsseoSpeed™ TX Profile 4.5 – 15 mm	18
25033	OsseoSpeed™ TX Profile 4.5 – 17 mm	18
25034	OsseoSpeed™ TX Profile 5.0 – 9 mm	18
25035	OsseoSpeed™ TX Profile 5.0 – 11 mm	18
25036	OsseoSpeed™ TX Profile 5.0 – 13 mm	18
25037	OsseoSpeed™ TX Profile 5.0 – 15 mm	18
25038	OsseoSpeed™ TX Profile 5.0 – 17 mm	18
25039	OsseoSpeed™ TX Profile 5.0 S – 9 mm	18
25040	OsseoSpeed™ TX Profile 5.0 S – 11 mm	18
25041	OsseoSpeed™ TX Profile 5.0 S – 13 mm	18
25042	OsseoSpeed™ TX Profile 5.0 S – 15 mm	18
25043	OsseoSpeed™ TX Profile 5.0 S – 17 mm	18
25062	Radiographic Implant Guides Profile	18
25052	Temporary Abutment Profile	19
25053	TiDesign™ Profile 4.5/5.0 – Ø 5.5, 1.8 mm	21
25054	TiDesign™ Profile 4.5/5.0 – Ø 5.5, 3.0 mm	21
25055	TiDesign™ Profile 4.5/5.0 – Ø 6.5, 1.8 mm	21
25056	TiDesign™ Profile 4.5/5.0 – Ø 6.5, 3.0 mm	21
25057	TiDesign™ Profile 4.5/5.0 – Ø 6.2, 2.7 mm, 15°	21

If you are not familiar with Atlantis™ patient-specific abutments, please contact your laboratory and/or your Astra Tech representative. For more information visit [www.atlantisabutment.com](http://www.atlantisabutment.com).





# Astra Tech BioManagement Complex™

A successful implant system cannot be determined by one single feature alone. Just as in nature, there must be several interdependent features working together. The following combination of key features is unique to the Astra Tech Implant System™:

- **OsseoSpeed™** – more bone more rapidly
- **MicroThread™** – biomechanical bone stimulation
- **Conical Seal Design™** – a strong and stable fit
- **Connective Contour™** – increased soft tissue contact zone and volume



## Australia

Astra Tech Pty Ltd.  
Suite 1, 53 Grandview St, Pymble NSW 2073  
☎ +61 2 9488 3500. 📠 +61 2 9440 0744  
[www.astratechdental.com.au](http://www.astratechdental.com.au)

## Austria

Astra Tech GesmbH  
Schloßhofer Straße 4/4/19, AT-1210 Wien  
☎ +43-(0)1-2146150. 📠 +43-(0)1-2146167  
[www.astratechdental.at](http://www.astratechdental.at)

## Benelux

Astra Tech Benelux B.V.  
Signaalrood 55, NL-2718 SG Zoetermeer  
☎ +31 79 360 1955/+32 3 232 81 50  
📠 +31 79 362 3748/+32 3 213 30 66  
[www.astratechdental.nl](http://www.astratechdental.nl)

## Canada

Astra Tech Inc.  
2425 Matheson Blvd East, 8th Floor  
Mississauga, ON L4W 5K4  
☎ +1 905 361 2844  
[www.astratechdental.com](http://www.astratechdental.com)

## Denmark

Astra Tech A/S  
Roskildevej 163, 1. th., DK-2620 Albertslund  
☎ +45 43 71 33 77. 📠 +45 43 71 78 65  
[www.astratechdental.dk](http://www.astratechdental.dk)

## East Asia

Astra Tech  
Suite 15.02, 15th Floor Menara PanGlobal  
No. 8 Lorong P Ramlee, MY-50250, Kuala Lumpur  
Malaysia  
☎ +60 3 27 11 2531. 📠 +60 3 27 11 2532  
[www.astratechdental.com](http://www.astratechdental.com)

## Finland

Astra Tech Oy  
PL 96, FI-02231 Espoo  
☎ +358 9 8676 1626. 📠 +358 9 804 4128  
[www.astratechdental.fi](http://www.astratechdental.fi)

## France

Astra Tech France  
7, rue Eugène et Armand Peugeot, TSA 90002  
FR-92563 Rueil Malmaison Cedex  
☎ +33 1 41 39 02 40. 📠 +33 1 41 39 02 44  
[www.astratechdental.fr](http://www.astratechdental.fr)

## Germany

Astra Tech GmbH  
An der kleinen Seite 8. DE-65604 Elz  
☎ +49 6431 9869 0. 📠 +49 6431 9869 500  
[www.astratechdental.de](http://www.astratechdental.de)

## Italy

Astra Tech S.p.A.  
Via Cristoni, 86, IT-40033 Casalecchio di Reno (BO)  
☎ +39 051 29 87 511. 📠 +39 051 29 87 580  
[www.astratechdental.it](http://www.astratechdental.it)

## Japan

Astra Tech K.K.  
Yaesuguchi-Daiei Building 12F  
1-3-1 Kyobashi, Chuo-ku, Tokyo 104-0031  
☎ +81 3 3243 5055. 📠 +81 3 3243 5057  
[www.astratech.jp](http://www.astratech.jp)

## Norway

Astra Tech AS  
Karihaugveien 89, NO-1086 Oslo  
☎ +47 67 92 05 50. 📠 +47 67 92 05 60  
[www.astratechdental.no](http://www.astratechdental.no)

## Poland

Astra Tech Sp. z o.o.  
ul. Oręzna 58, PL-02-937 Warszawa  
☎ +48 22 853 67 06. 📠 +48 22 853 67 10  
[www.astratechdental.pl](http://www.astratechdental.pl)

## Portugal

Astra Tech  
Lagoas Park, Edifício 8 – 1º piso  
PT-2740-268 Porto Salvo  
☎ +351 21 421 2273. 📠 +351 21 421 0234  
[www.astratechdental.pt](http://www.astratechdental.pt)

## Russia

Astra Tech Russia  
2, Maly Magiltsevsky pereulok  
RU-119 002 Moscow  
☎ +7 495 937 5037  
[www.astratechdental.com](http://www.astratechdental.com)

## Spain

Astra Tech S.A.  
Calle Ciencias nº 73 derecha. Nave 9,  
Polígono Industrial Pedrosa,  
ES-08908 L'Hospitalet de Llobregat  
☎ Servicio al cliente: +34.902.101.558  
☎ +34.932.643.560. 📠 +34.933.363.231  
[www.astratechdental.es](http://www.astratechdental.es)

## Sweden

Astra Tech AB  
P.O. Box 14, SE-431 21 Mölndal  
☎ +46 31 776 30 00. 📠 +46 31 776 30 17  
[www.astratechdental.se](http://www.astratechdental.se)

## Switzerland

Astra Tech SA  
Avenue de Sévelin 18, P.O. Box 54  
CH-1000 Lausanne 20  
☎ +41 21 620 02 30. 📠 +41 21 620 02 31  
[www.astratechdental.ch](http://www.astratechdental.ch)

## United Kingdom

Astra Tech Ltd.  
Brunel Way, Stonehouse, Glos GL10 3SX  
☎ +44 845 450 0586. 📠 +44 1453 791001  
[www.astratechdental.co.uk](http://www.astratechdental.co.uk)

## USA

Astra Tech Inc.  
590 Lincoln Street, Waltham, MA 02451  
☎ +1-800-531-3481. 📠 +1-781-890-6808  
[www.astratechdental.com](http://www.astratechdental.com)

## Other Markets

Astra Tech AB, Export Department  
P.O. Box 14, SE-431 21 Mölndal, Sweden  
☎ +46 31 776 30 00. 📠 +46 31 776 30 23  
[www.astratechdental.com](http://www.astratechdental.com)



Astra Tech AB, Aminogatan 1, P.O. Box 14, SE-431 21 Mölndal, Sweden  
☎ +46 31 776 30 00. 📠 +46 31 776 30 10. [www.astratechdental.com](http://www.astratechdental.com)